



HOBAS® Make things happen.

HOBAS megoldások a csapadékvíz gazdálkodásban

Veszprémi Zsuzsanna
HOBAS Hungária Kft.

Baja, 2017.11.15.



HOBAS® Make things happen.

ÖSSZEFOGLALÓ

- CÉG
- TERMÉKEK
- 1. ELVEZETÉS
- 2. LEVÁLASZTÁS
- 3. TÁROZÁS
- 4. HASZNOSÍTÁS

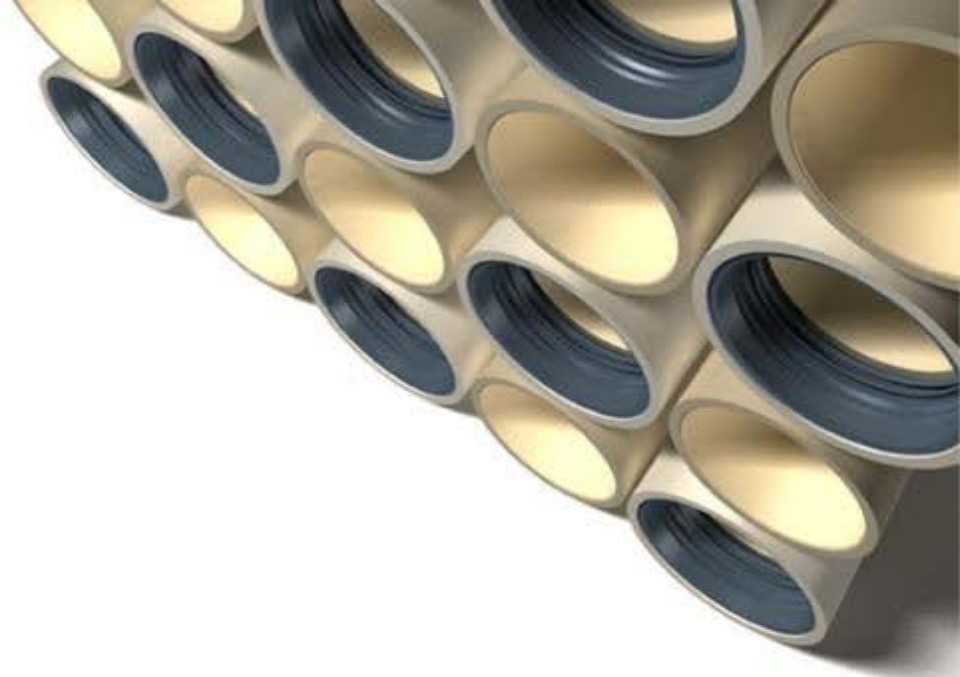



HOBAS® Make things happen.

AMIBLU csoport

- A HOBAS és a Flowtite egyesülésével (50-50%)
- Fenntartható megoldások
- Bővülő termékkínálat





HOBAS® Make things happen.

A HOBAS csoport

- 100 éves családi vállalkozás egyik cégcsoportja
- Több mint fél évszázada a CC-GRP csőgyártásban
- Gyárak világszerte
- Képviselet minden kontinensen
- Képviselet a legtöbb európai országban
- 15 éve Magyarországon a HOBAS Hungária Kft.



HOBAS® Make things happen.

Az AMIANTIT csoport

- Nemzetközi vállalkozás egyik cégcsoportja
- GRP csőgyártás (tekerceselt FW és centrifugálisan öntött CC)
- Gyárak világszerte
- Képviselet minden kontinensen
- Képviselet a legtöbb európai országban



HOBAS® Make things happen.

Csapadék előfordulás szélsőségek



Baja 2017.11.15.



HOBAS® Make things happen.

Miért fontos a csapadékvízzel gazdálkodni?

- Természeti erőforrás
- Időben és térben egyenetlen eloszlású
- Meghatározott helyen és időben van rá szükségünk



HOBAS® Make things happen.

Mit kezdünk a csapadékvízzel?

- Tartsuk helyben
- Vezessük el
- Tároljuk valahol
- Használjuk fel
- Pótoljuk ahol hiányzik



HOBAS® Make things happen.

Megoldás szempontjai

- Műszakilag megfelelő
- Költséghatékony
- Fenntartható
- Könnyen üzemeltethető
- Könnyen telepíthető
- Helyi igényekre szabott



HOBAS® Make things happen.

HOBAS csőrendszerek

- CC-GRP csövek

- DN150 – DN3600

- PN1 – PN16 (PN32)

- Idomok

- Tartályok, aknák, átemelők, zápor-túlfolyós leválasztó, ...



HOBAS® Make things happen.

HOBAS csövek tiszta gyanta belső védőréteggel

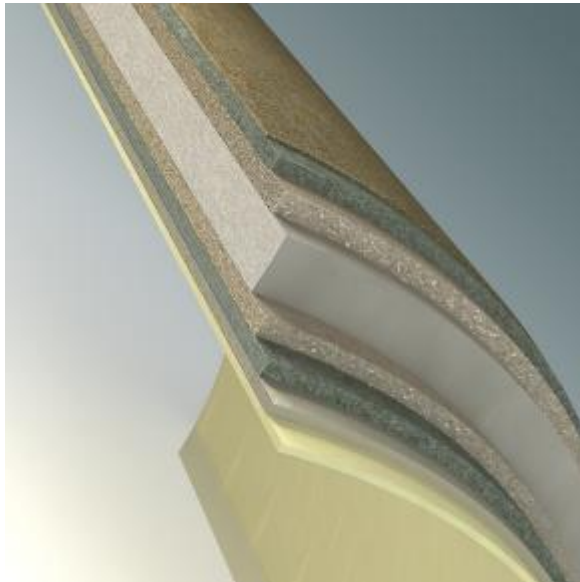



HOBAS® Make things happen.

A legújabb termék: csövek PU belső védőréteggel

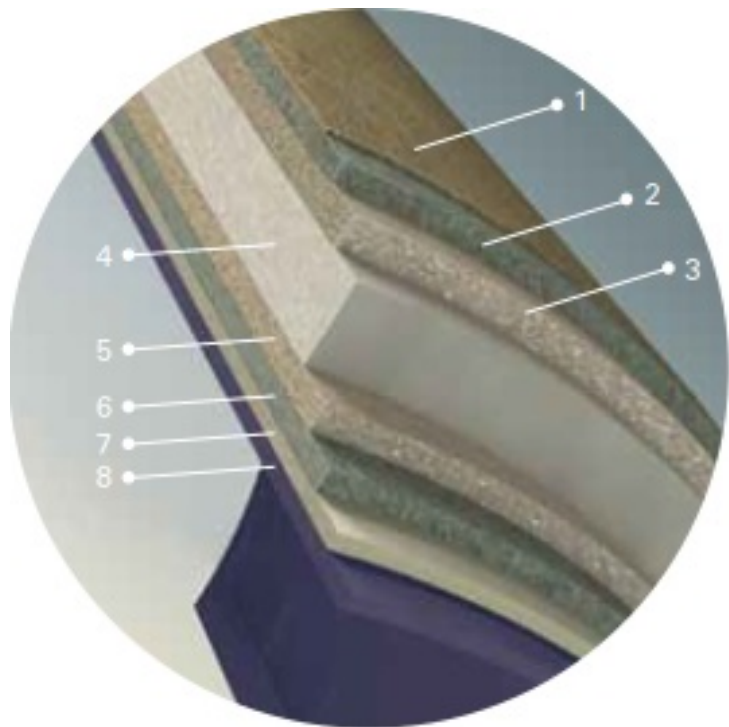

HOBAS CSO ZVE





HOBAS® Make things happen.

1. Csapadékvíz elvezetés

- PI. Szombathely, Rohonci utca, csapadékvíz elvezetés
- DN900 csővezeték
- DN2000 csőből készült aknák
- Speciális kialakítások



HOBAS® Make things happen.

Így szállítottuk



Baja 2017.11.15.



HOBAS® Make things happen.



Baja 2017.11.15.



HOBAS® Make things happen.



Baja 2017.11.15.



HOBAS® Make things happen.

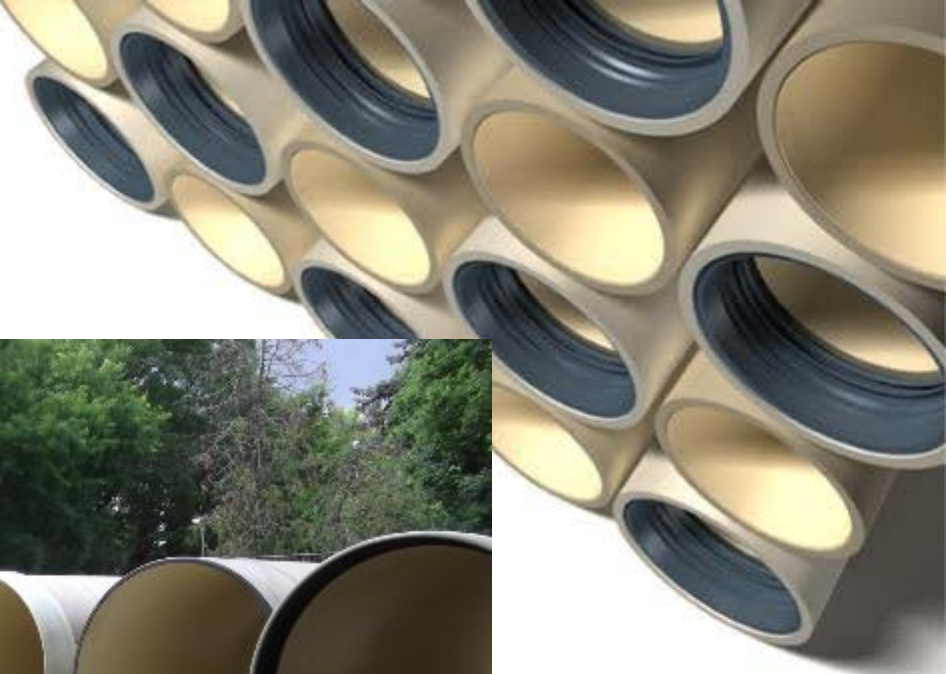

Baja 2017.11.15.



HOBAS® Make things happen.



Baja 2017.11.15.



HOBAS® Make things happen.



Baja 2017.11.15.



HOBAS® Make things happen.

Cső + akna HOBAS rendszer előnyei

- Tökéletesen vízzáró
- Kiváló hidraulikai jellemzők
- Korrózióálló
- Hosszú élettartam
- Bonyolult csomópontok megvalósítása
- Kis tömeg
- Könnyű, nagy pontosságú telepítés



HOBAS® Make things happen.

Elvezetés – száraz időszakok

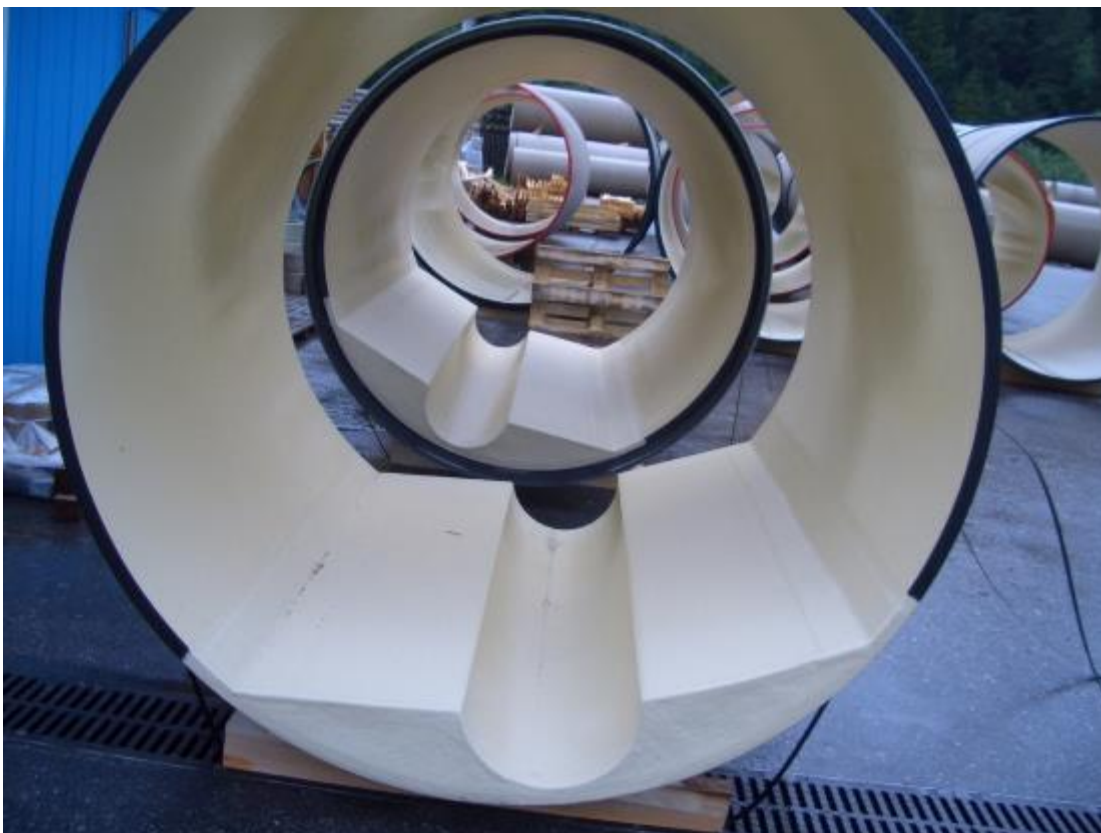

Baja 2017.11.15.



HOBAS® Make things happen.

Száraz időszakban



Baja 2017.11.15.



HOBAS® Make things happen.

Híd csapadékvíz elvezetés Szébényi-híd



Baja 2017.11.15.



HOBAS® Make things happen.



2. Zápor-túlfolyós leválasztó

- Prágai Műszaki Egyetemen – Doc. Ing. Jaroslav Pollert - együtt kidolgozva
- Speciális termék, projektre szabva, egyéni elvárásokhoz igazítva
- Kedvező tapasztalatok már több éve, mért eredményekkel igazolva
- Eredményesen választja le az **egyesített rendszerekben** a lebegő szilárd szennyeződések



HOBAS® Make things happen.

Zápor-túlfolyós leválasztó működési elve

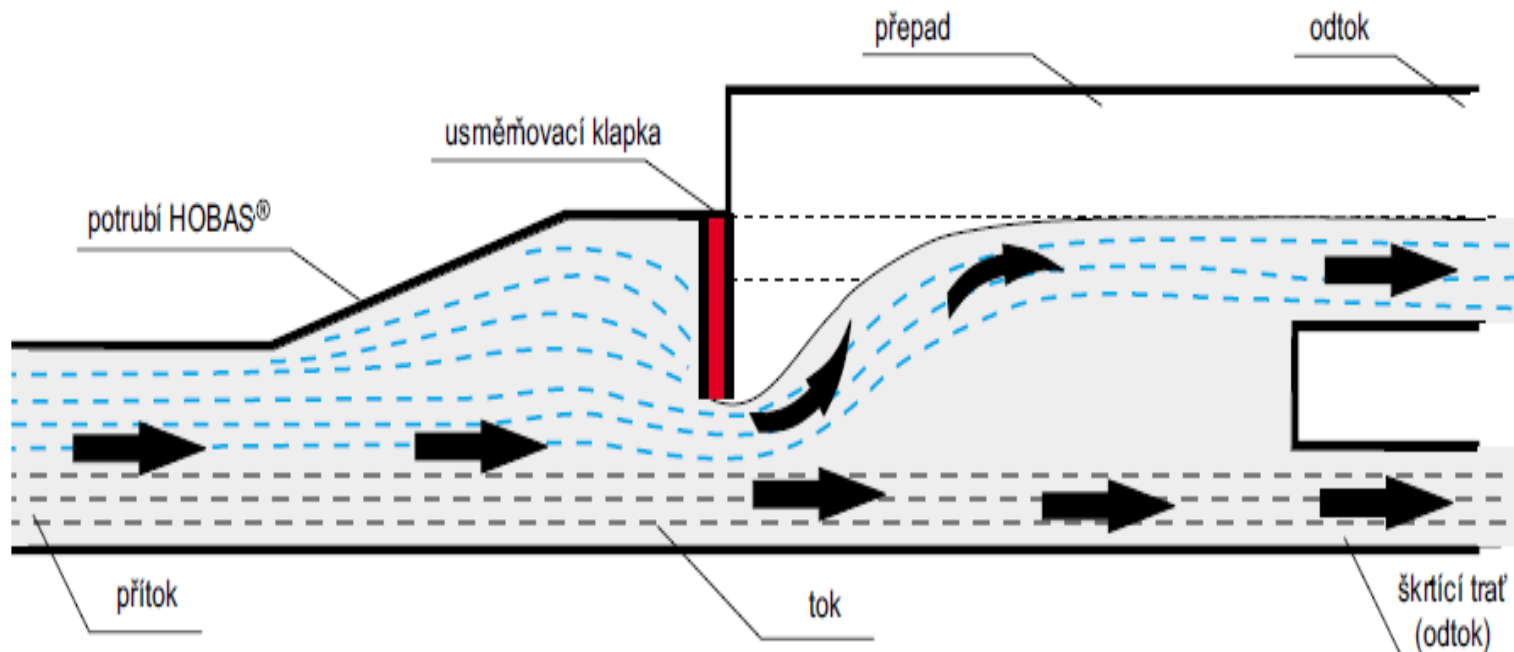



HOBAS® Make things happen.

Fizikai modellezés

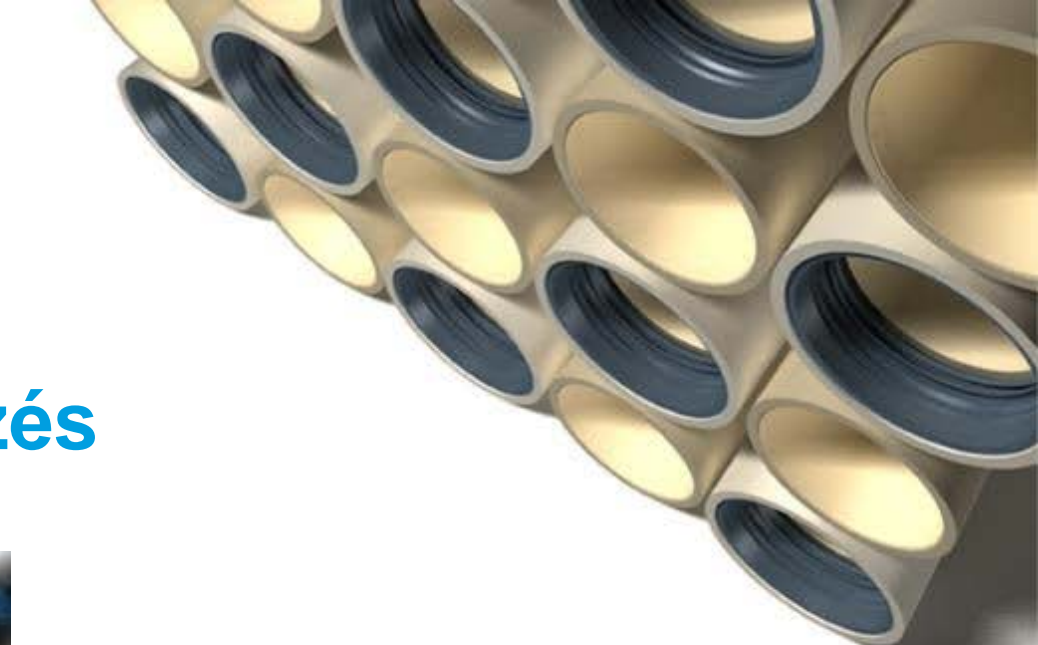

Baja 2017.11.15.



HOBAS® Make things happen.

Matematikai modellezés

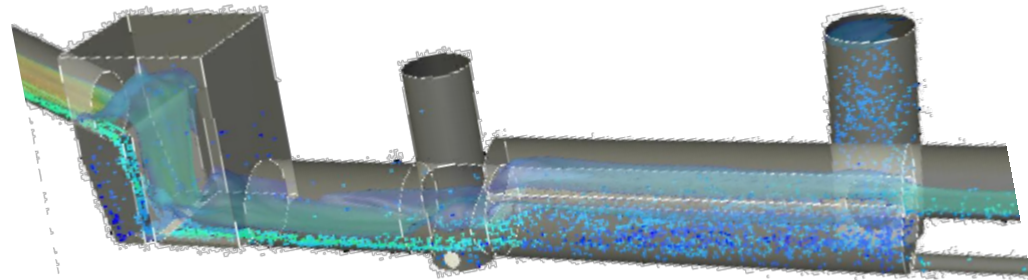
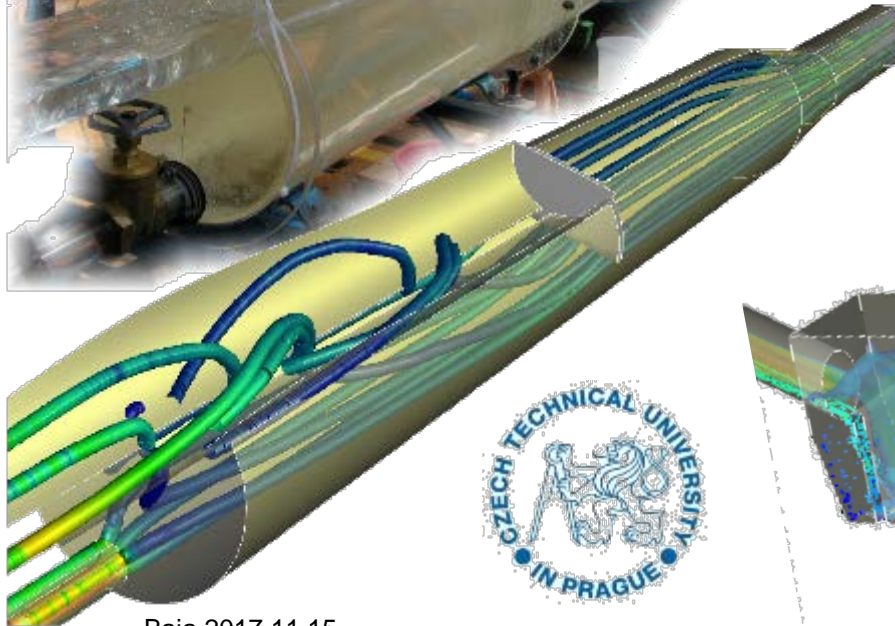
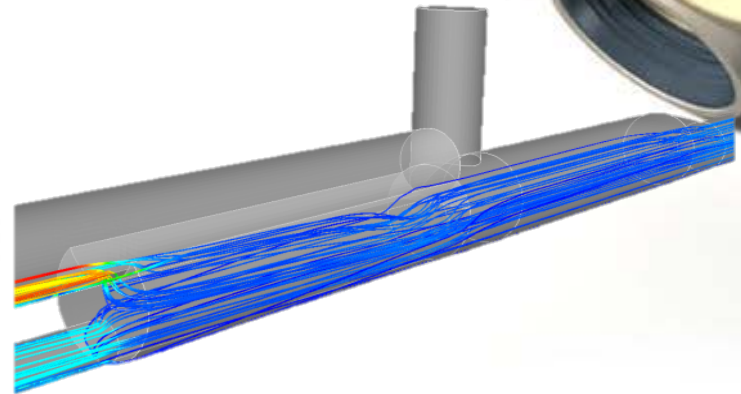
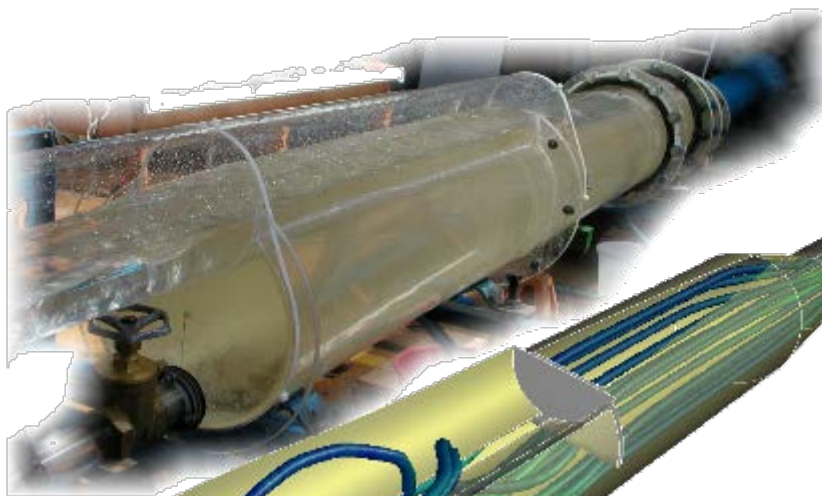

Baja 2017.11.15.



HOBAS® Make things happen.

Eredmény



Baja 2017.11.15.





HOBAS® Make things happen.

Változatos megoldások



Baja 2017.11.15.



HOBAS® Make things happen.



Baja 2017.11.15.



HOBAS® Make things happen.



Baja 2017.11.15.



HOBAS® Make things happen.

3. Tárolás

Staukanal DN 2400 Stauvolumen 170 m³, Länge = 40 m

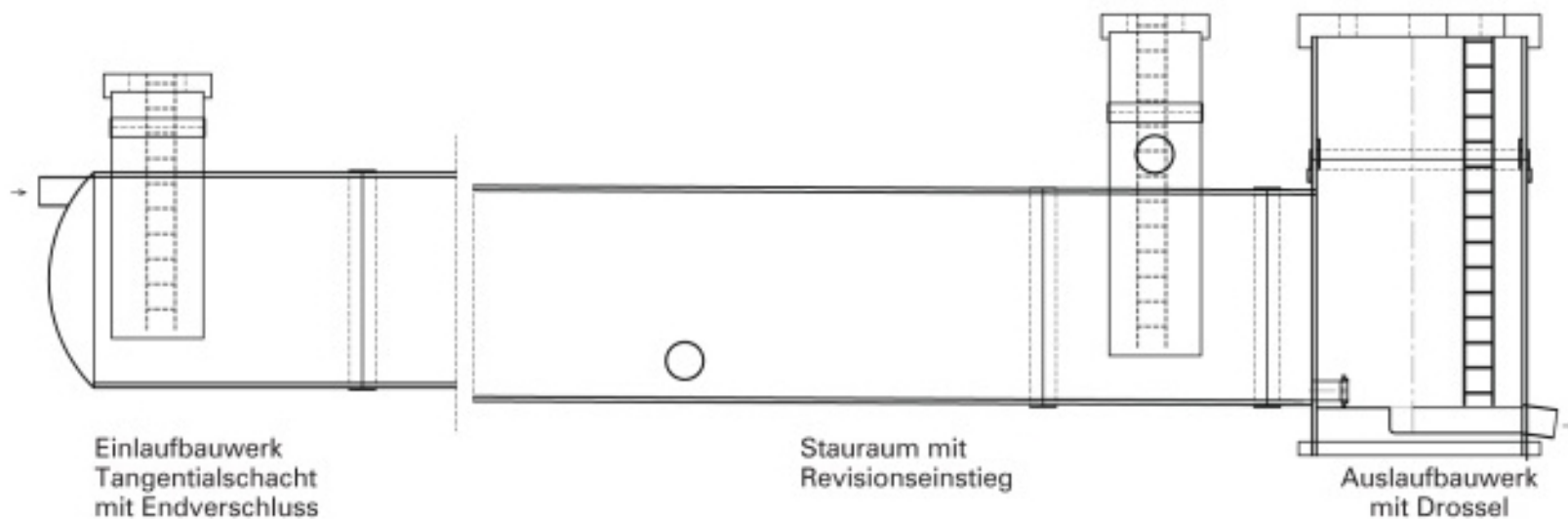



HOBAS® Make things happen.

Tárolás

Stauraumsystem DN 1800 Stauvolumen 800 m³, Länge = 328 m

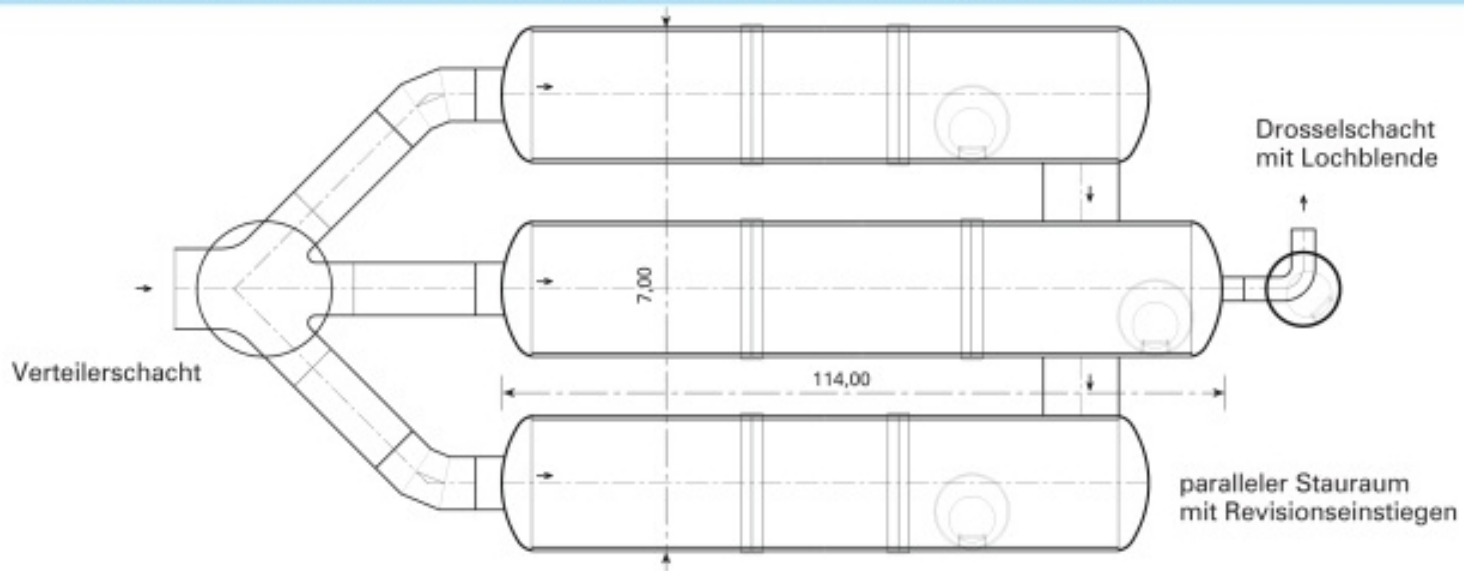



HOBAS® Make things happen.

Tárolás

Stauraumsystem DN 1500 Stauvolumen 220 m³

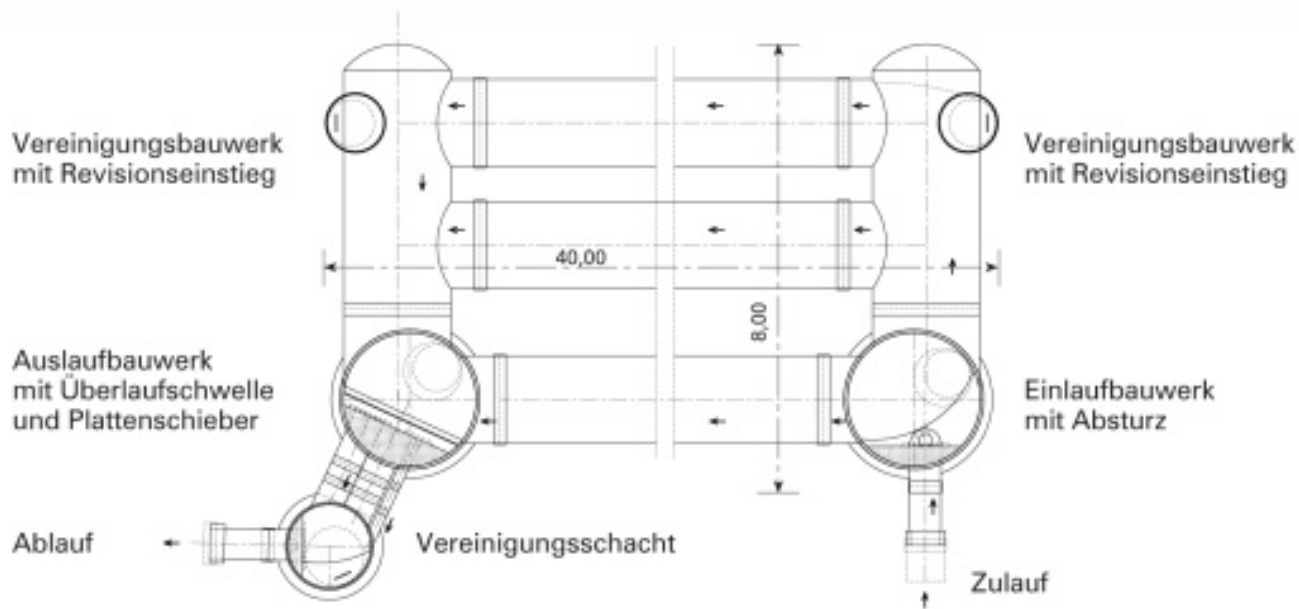



HOBAS® Make things happen.

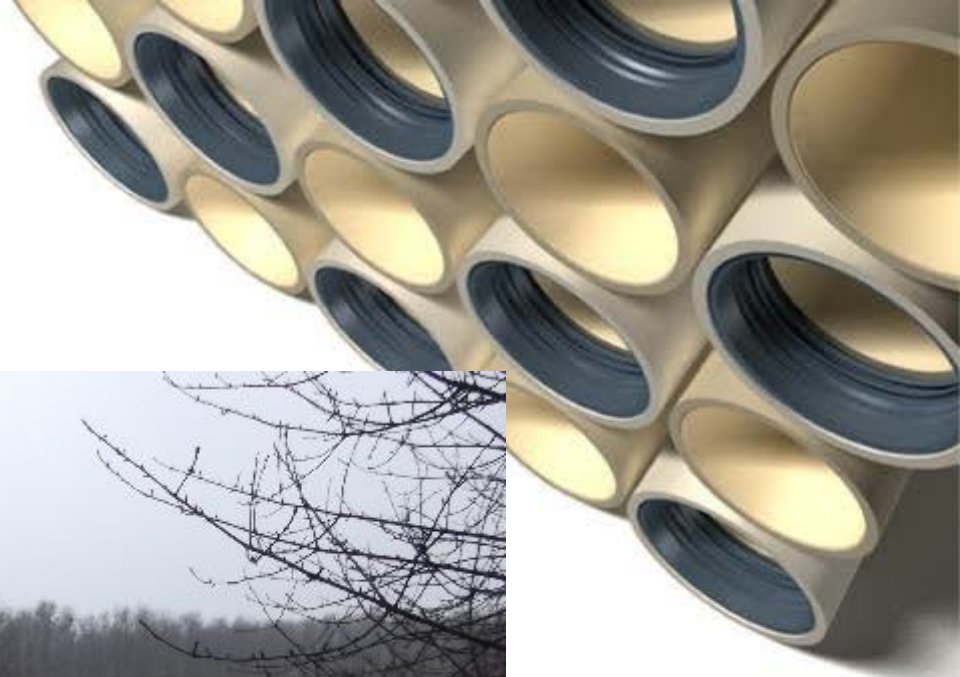

Baja 2017.11.15.



HOBAS® Make things happen.



Baja 2017.11.15.



HOBAS® Make things happen.



Baja 2017.11.15.



HOBAS® Make things happen.



Baja 2017.11.15.



HOBAS® Make things happen.

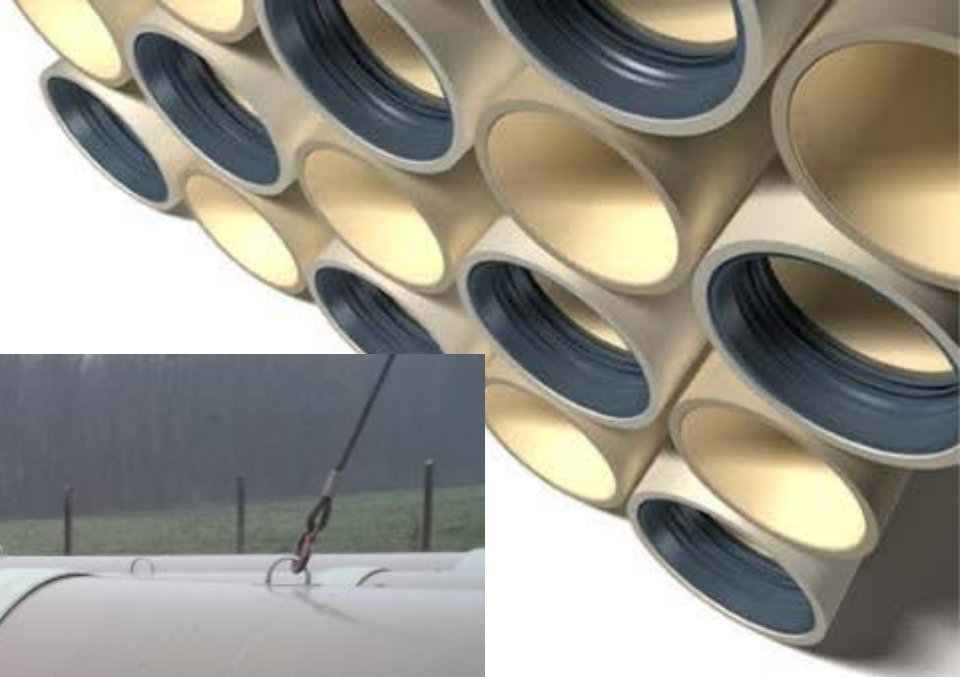

Baja 2017.11.15.



HOBAS® Make things happen.



Baja 2017.11.15.



HOBAS® Make things happen.

Tárolás – hasznosítás

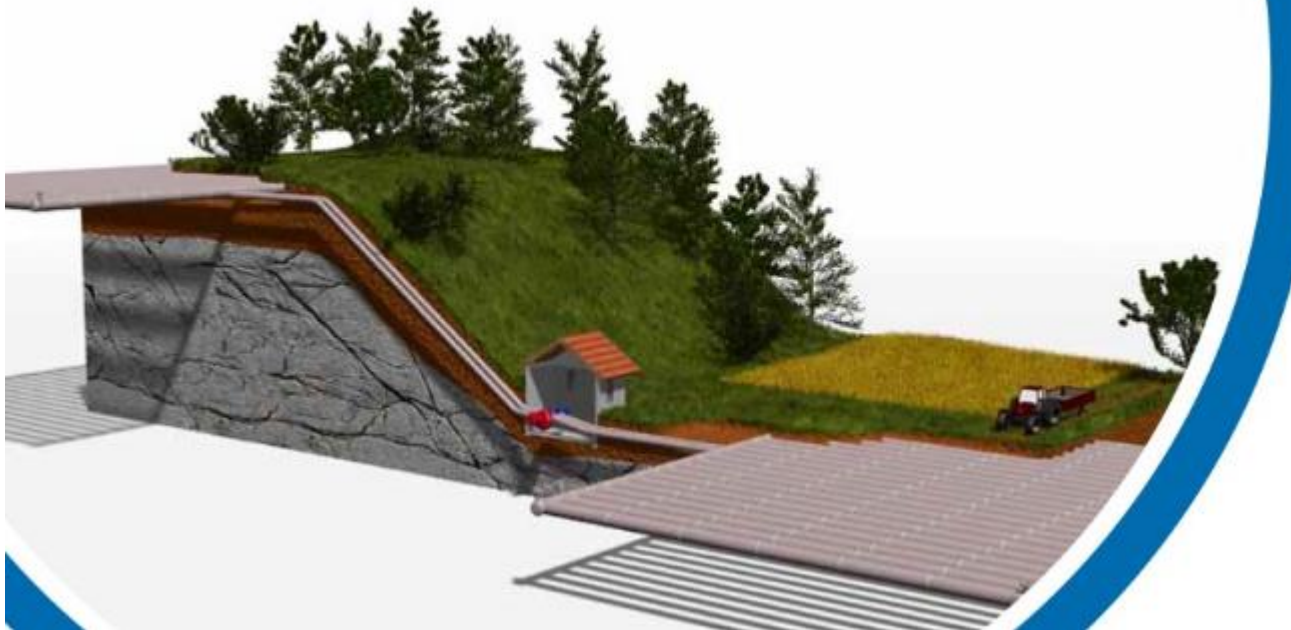

Baja 2017.11.15.



HOBAS® Make things happen.

4. Vízpótlás

- Környezetvédelmi (vizes élőhely megóvás) beruházás, öntözési potenciállal
- Váltakozva nyílt árkos és zárt csővezetékes szakaszokkal



HOBAS® Make things happen.

Köszönöm a figyelmet!